



meite®

LOCK

BeA®

VERTEX



FASTENERS INC.



meite®



LOCK



BeA®

VERTEX  FASTENERS INC.





COIL NAIL

ตะปูม้วน

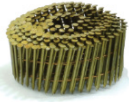

CN55
CN70B
CN80B
CN100B

FC : ป้ายแหลม

FC32V1	FC38V1	FC45V1	FC45V5	FC50V5	FC57V5	FC65V5	FC75W1	FC90W1	FC100W1
●	●	●	●		●	●		●	
									●

FS : เกลียวป้ายแหลม

FS32V1	FS38V1	FS45V1	FS45V5	FS50V5	FS57V5	FS65V5	FS75W1	FS90W1	FS100W1
●	●	●	●		●	●		●	
									●

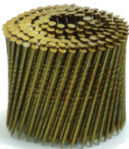

CN55
CN70B
CN80B
CN100B

FC(C) : ป้ายตัด

FC32V1C	FC38V1C	FC45V1C	FC45V5C	FC50V5C	FC57V5C	FC65V5C	FC75W1C	FC90W1C	FC100W1C
●	●	●	●		●	●		●	
									●

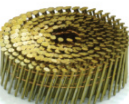

CN55
CN70B
CN80B
CN100B

FS(C) : เกลียวป้ายตัด

FS32V1C	FS38V1C	FS45V1C	FS45V5C	FS50V5C	FS57V5C	FS65V5C	FS75W1C	FS90W1C	FS100W1C
●	●	●	●		●	●		●	
									●



CN55
CN70B
CN80B
CN100B



meite®

LOCK

BeA®

VERTEX FASTENERS INC.

INDUSTRIAL COIL NAILER

MEITE INDUSTRIAL COIL NAILER

เครื่องยิงประตู่ก้อน

CN55

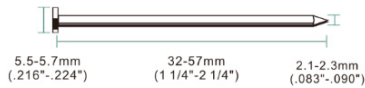

TOOL SPECIFICATIONS

WEIGHT	2.75 KG / 6.06 LBS
HEIGHT	283MM / 11.14"
LENGTH	270MM / 10.62"
WIDTH	131MM / 5.15"
CAPACITY	300-400 PCS
OPERATING PRESSURE	70-100 PSI
AIR INLET	1/4" NPT
TRIGGER	CONTACT

FASTENER

TYPE	WIRE / PLASTIC COLLATED COIL NAILS
LENGTH	32-57 MM (1 1/4"-2 1/4")
SHANK DIA	2.1-2.3 MM (.082"-.090")
HEAD DIA	5.5-5.7 MM (.216"-.224")
NAIL PITCH	6.8 MM (.267")
SHANK TYPE	SMOOTH, SCREW & RING

FEATURES	APPLICATIONS	SIMILAR TOOLS
- POWERFUL FOR HEAVY-DUTY APPLICATIONS	- PALLET	- MAX CN55
- WELL-BALANCED, COMFORT RUBBER GRIP	- CRATES & WOOD CASES	- BEA 550DC
- BUMP FIRING TRIGGER FOR HIGH SPEED OPERATION	- SHEATHING	- BOSTITCH N57C
- DURABLE DRIVER AND BUMPER FOR LONG LIFE	- SIDING	- SENCO PALLET PRO 57F
- ACCURATE NOSE, MINIMIZE NAIL JAM	- FENCING	
	- DECKING	

CN70B

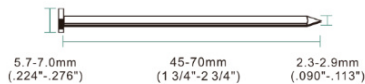

TOOL SPECIFICATIONS

WEIGHT	3.84 KG / 8.47 LBS
HEIGHT	318 MM / 12.51"
LENGTH	336 MM / 13.22"
WIDTH	143 MM / 5.62"
CAPACITY	225-300 PCS
OPERATING PRESSURE	70-100 PSI
AIR INLET	1/4" NPT
TRIGGER	CONTACT

FASTENER

TYPE	WIRE / PLASTIC COLLATED COIL NAILS
LENGTH	45-70 MM (1 3/4"- 2 3/4")
SHANK DIA	2.3-2.9MM (0.90"-. 1.14")
HEAD DIA	5.7-7.0 MM (.224".275")
NAIL PITCH	8 MM (.314")
SHANK TYPE	SMOOTH, SCREW & RING

FEATURES	APPLICATIONS	SIMILAR TOOLS
- POWERFUL FOR HEAVY DUTY APPLICATIONS	- PALLETS	- MAX CN70
- WELL-BALANCED, COMFORT RUBBER GRIP	- CRATES & WOOD CASES	- BOSTITCH N57C
- BUMP FIRING TRIGGER FOR HIGH SPEED OPERATION	- FRAMING	- BEA 700DC
- DURABLE DRIVER AND BUMPER FOR LONG LIFE	- DECKING	
- ACCURATE NOSE, MINIMIZE NAIL JAM	- FENCING	
	- PACKAGING	

CN80B

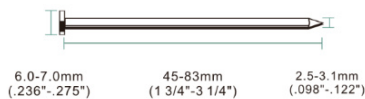

TOOL SPECIFICATIONS

WEIGHT	4.02 KG / 8.86 LBS
HEIGHT	348 MM / 13.70"
LENGTH	347 MM / 13.66"
WIDTH	137 MM / 5.39"
CAPACITY	225-300 PCS
OPERATING PRESSURE	70-100 PSI
AIR INLET	1/4" NPT
TRIGGER	CONTACT

FASTENER

TYPE	WIRE COLLATED COIL NAILS
LENGTH	45-83 MM (1 3/4"-1 3/4")
SHANK DIA	2.5-3.1 MM (0.98"-. 1.22")
HEAD DIA	6.0-7.0 MM (.236"-.275")
NAIL PITCH	8 MM (.314")
SHANK TYPE	SMOOTH, SCREW & RING

FEATURES	APPLICATIONS	SIMILAR TOOLS
- POWERFUL FOR HEAVY DUTY APPLICATIONS	- PALLETS	- MAX CN80
- WELL-BALANCED, COMFORT RUBBER GRIP	- CRATES & WOOD CASES	- BOSTITCH N80CB
- BUMP FIRING TRIGGER FOR HIGH SPEED OPERATION	- PACKAGING	- BEA 800DC
- DURABLE DRIVER AND BUMPER FOR LONG LIFE	- DECKING	
- ACCURATE NOSE, MINIMIZE NAIL JAM	- SHEATHING	

CN100B



TOOL SPECIFICATIONS

WEIGHT	5.67 KG / 12.5 LBS
HEIGHT	420 MM / 16.53"
LENGTH	370 MM / 14.56"
WIDTH	159 MM / 6.25"
CAPACITY	225-300 PCS
OPERATING PRESSURE	100-120 PSI
AIR INLET	3/8" NPT
TRIGGER	CONTACT

FASTENER

TYPE	WIRE / PLASTIC COLLATED COIL NAILS
LENGTH	65-100 MM (2 1/2"-4")
SHANK DIA	2.5-3.3 MM (0.99"-1.31")
HEAD DIA	6.2-7.2 MM (.244-.283")
NAIL PITCH	10.5 MM (.413")
SHANK TYPE	SMOOTH, SCREW & RING

FEATURES	APPLICATIONS	SIMILAR TOOLS
- POWERFUL FOR HEAVY DUTY APPLICATIONS	- PALLET	- SENCO PALLET PRO 100
- WELL-BALANCED, COMFORT RUBBER GRIP	- CRATES & WOOD CASES	- BOSTITCH N400C
- RUBBER COMFORT GRIP	- PACKAGING	- MAX CN100
- DOWNWARD DIRECTIONAL EXHAUST	- DECKING	
- DURABLE DRIVER AND BUMPER FOR LONG LIFE	- SHEATHING	

MEITE HEAVY WIRE STAPLER SERIES

เครื่องยิงลวดดัก

N851F



TOOL SPECIFICATIONS

WEIGHT	2.8 KG / 6.17 LBS
HEIGHT	287 MM / 11.29"
LENGTH	340 MM / 13.38"
WIDTH	100 MM / 3.93"
CAPACITY	140 PCS
OPERATING PRESSURE	80-120 PSI
AIR INLET	1/4" NPT
TRIGGER	CONTACT

FASTENER

TYPE	16 GA HEAVY WIRE STAPLES
LENGTH	25-50 MM (1"-2")
SHANK DIA	1.6 MM (.062")
HEAD DIA	1.4 MM (.055")
NAIL PITCH	10.8 MM (7/16")
SHANK TYPE	GLUED STRIP

FEATURES	APPLICATIONS	SIMILAR TOOLS
- POWERFUL	- SOLID WOOD FURNITURE	- BEA 14/50-763
- RUBBER COMFORT GRIP	- WOODEN PACKING BOXES	- SENCO SN45XP
- WELL-BALANCED	- SOFA FRAME	- HITACHI N5008A
	- SHEATHING	- BOSTITCH 650S5-1
	- ROOF DECKING	
	- SUBFLOORING ETC	

PW2538

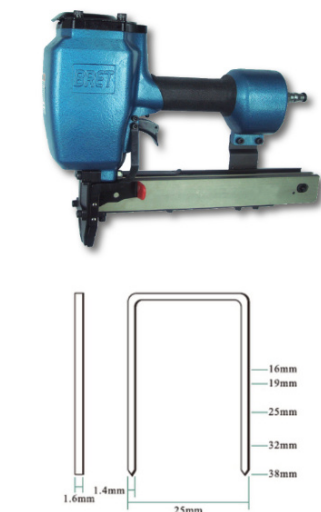

TOOL SPECIFICATIONS

WEIGHT	3.37 KG / 7.43 LBS
L X W X H	350 X 100 X 287 (MM)
	14" X 4" X 11 1/2"
CAPACITY	140 PCS
AIR PRESSURE	80-120 PSI
AIR INLET	3/8" NPT

FASTENER

LENGTH	16-38 MM (5/8"-1 1/2")
WIDTH X THICKNESS:	1.6 X 1.4 MM (.063" X .055")
CROWN	26.4 MM (1")
COLLATION TYPE	GLUED STRIP

FEATURES	APPLICATIONS	SIMILAR TOOLS
- POWERFUL FOR HEAVY DUTY APPLICATIONS	- WINDOW DOOR	- SENCO WC150XP
- RUBBER COMFORT GRIP	- CORRUGATED CARTON TO SKID	- BOSTITCH 43852-1
- LIGHT WEIGHT		



MEITE NAIL REMOVING

เครื่องถอนตะปู

T50SC



TOOL SPECIFICATIONS

WEIGHT	1.06KG / 2.34LBS	CAPACITY	/
HEIGHT	228MM / 8.97"	OPERATING PRESSURE	60-100PSI
LENGTH	282MM / 11.10"	AIR INLET	1/4"NPT
WIDTH	62MM / 2.44"	TRIGGER	TRIGGER

FEATURES	APPLICATIONS
TOOL FOR PALLET REPAIRING	PALLET
LIGHT WEIGHT & WELL - BALANCED	CRATES & WOOD CASES
RUBBER COMFORT GRIP	PACKAGING
DURABLE DRIVER AND BUMPER FOR LONG LIFE	



NP55



TOOL SPECIFICATIONS

WEIGHT	2.0KG / 4.41LBS	CAPACITY	/
HEIGHT	276MM / 1086"	OPERATING PRESSURE	60-100PSI
LENGTH	298MM / 11.73"	AIR INLET	1/4"NPT
WIDTH	88MM / 3.46"	TRIGGER	TRIGGER

FEATURES	APPLICATIONS
TOOL FOR PALLET REPAIRING	PALLET
LIGHT WEIGHT & WELL - BALANCED	CRATES & WOOD CASES
RUBBER COMFORT GRIP	PACKAGING
DURABLE DRIVER AND BUMPER FOR LONG LIFE	
POWERFUL FOR HEAVY-DUTY APPLICATIONS	



NP70



TOOL SPECIFICATIONS

WEIGHT	2.73KG / 6.02LBS	CAPACITY	/
HEIGHT	109MM / 4.29"	OPERATING PRESSURE	85-115PSI
LENGTH	343MM / 13.50"	AIR INLET	1/4"NPT
WIDTH	303MM / 11.92"	TRIGGER	TRIGGER

FEATURES	APPLICATIONS
TOOL FOR PALLET REPAIRING	PALLET
LIGHT WEIGHT & WELL - BALANCED	CRATES & WOOD CASES
RUBBER COMFORT GRIP	PACKAGING
DURABLE DRIVER AND BUMPER FOR LONG LIFE	
POWERFUL FOR HEAVY-DUTY APPLICATIONS	



TSN STAPLER

เครื่องยิงลวดและเครื่องยิงตะปูแฉง

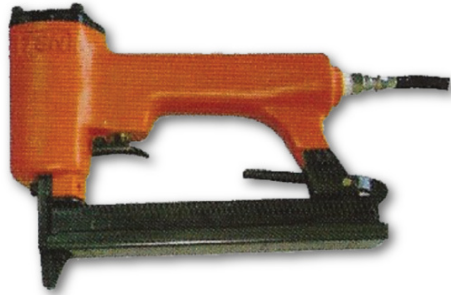
STAPLER เครื่องยิงตะปูแฉง
รุ่น TSN-30 / F30 สำหรับงานไม้

SPECIFICATIONS

น้ำหนัก	1.2 กก.
ขนาด (ก X ย X อ)	50 X 240 X 175
ความจุตะปู	100 ตัว
ความดันลม	4 - 7 กก. / ตร.ซม.
ขนาดเส้นผ่าศูนย์กลางภายในของสายลม	5 มม.

TSN FINISHNAIL (STEEL, STAINLESS)

ตะปูแฉงหัวเล็ก "ฟิโอสตีล" ทำจากเหล็กชุบสังกะสี และสแตนเลส ลวดมี 3 สี คือ สีทอง สีทอง และ สีเทาอ่อน

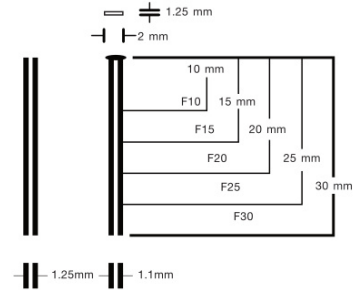
STAPLER เครื่องยิงลวด
รุ่น TSN-20 / 1013J

SPECIFICATIONS

ความจุลวด	100 ตัว
น้ำหนักเครื่อง	0.91 กก.
ความดันลม	3.5 - 7 กก. / ตร.ซม.
ขนาดรูในของสายลม	5 มม.

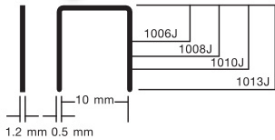
STAPLER เครื่องยิงลวด
รุ่น TSN-30 / 1022J

SPECIFICATIONS

ความจุลวด	100 ตัว
น้ำหนักเครื่อง	1.2 กก.
ความดันลม	4 - 7 กก. / ตร.ซม.
ขนาดรูในของสายลม	5 มม.

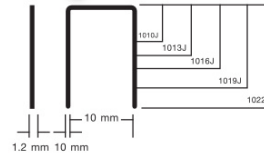

BEA STAPLER

เครื่องยิงลวด



FINE WIRE STAPLER

J10/16-435

SPECIFICATIONS

WEIGHT	0.9 KG
L X W X H	228 X 42 X 152
OPERATING PRESSURE	5-8 BAR
ใช้ลวด	1004 - 1016J

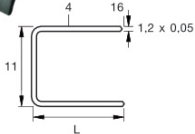

MEDIUM DUTY STAPLER

90/40-711

SPECIFICATIONS

WEIGHT	2.1 KG
L X W X H	343 X 70 X 228
OPERATING PRESSURE	5-8 BAR
ใช้ลวด	92/15 - 92/40

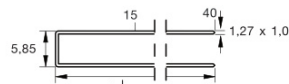

HEAVY DUTY STAPLER

14/50-763

SPECIFICATIONS

WEIGHT	2.14 KG
L X W X H	334 X 70 X 244
OPERATING PRESSURE	5-8 BAR
ใช้ลวด	825T - 850T



MEDIUM DUTY STAPLER

92/40-722

SPECIFICATIONS

WEIGHT	1.34 KG
L X W X H	221 X 70 X 228
OPERATING PRESSURE	5-8 BAR
ใช้ลวด	415MA - 440MA

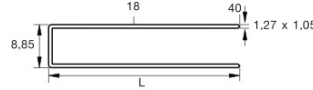



meite®

LOCK

BeA®

VERTEX FASTENERS INC.

C-RING PLIER SERIES

MEITE C-RING PLIER SERIES

เครื่องเย็บ C-Ring

SC760B

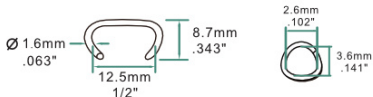

TOOL SPECIFICATIONS

WEIGHT	1.63KG/3.59LBS
HEIGHT	201MM/7.91"
LENGTH	330MM/12.99"
WIDTH	84MM/3.30"
CAPACITY	100PCS
OPERATING PRESSURE	70-100PSI
AIR INLET	1/4"NPT
TRIGGER	TRIGGER

FASTENER

TYPE	TAPE COLLATED C-RING
LENGTH	16GA
SHANK DIA	1.6MM(.063")
HEAD DIA	12.5MM(1/2")
NAIL PITCH	2.6-3.6MM(.102"-.141")
SHANK TYPE	GALVANIZED, ALUMINUM, STAINLESS

FEATURES

- WELL-BALANCED, ERGONOMICALLY DESIGNED
- LARGE CAPACITY LONG MAGAZINE
- RUBBER COMFORT GRIP
- CAN BE EASILY CONVERTED TO RIGHT OR LEFT HAND OPERATION

APPLICATIONS

- WIRE CAGE
- CAR SEAT
- SPRING MATTRESS
- BAG CLOSURE

SIMILAR TOOLS

- BOSTITCH SC760
- MEIHO MC-660

SC7C

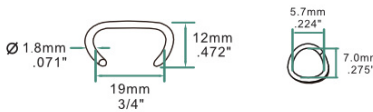

TOOL SPECIFICATIONS

WEIGHT	1.68KG/3.70LBS
HEIGHT	201MM/7.91"
LENGTH	338MM/13.30"
WIDTH	84MM/3.30"
CAPACITY	100PCS
OPERATING PRESSURE	70-100PSI
AIR INLET	1/4"NPT
TRIGGER	TRIGGER

FASTENER

TYPE	TAPE COLLATED C-RING
LENGTH	15GA
SHANK DIA	1.8MM(.070")
HEAD DIA	19MM(3/4")
NAIL PITCH	5.7-7.0MM(.224"-.275")
SHANK TYPE	GALVANIZED, ALUMINUM, STAINLESS

FEATURES

- WELL-BALANCED, ERGONOMICALLY DESIGNED
- LARGE CAPACITY LONG MAGAZINE
- RUBBER COMFORT GRIP
- CAN BE EASILY CONVERTED TO RIGHT OR LEFT HAND OPERATION

APPLICATIONS

- WIRE CAGE
- CAR SEAT
- SPRING MATTRESS
- BAG CLOSURE

SIMILAR TOOLS

- BOSTITCH SC7C
- MEIHO MC-6CA

SC7E

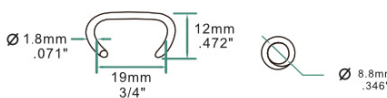

TOOL SPECIFICATIONS

WEIGHT	1.74KG/3.84LBS
HEIGHT	201MM/7.91"
LENGTH	349MM/13.74"
WIDTH	84MM/3.30"
CAPACITY	100PCS
OPERATING PRESSURE	70-100PSI
AIR INLET	1/4"NPT
TRIGGER	TRIGGER

FASTENER

TYPE	TAPE COLLATED C-RING
LENGTH	15GA
SHANK DIA	1.8MM(.070")
HEAD DIA	19MM(3/4")
NAIL PITCH	8.8MM(.346")
SHANK TYPE	GALVANIZED, ALUMINUM, STAINLESS

FEATURES

- WELL-BALANCED, ERGONOMICALLY DESIGNED
- LARGE CAPACITY LONG MAGAZINE
- RUBBER COMFORT GRIP
- CAN BE EASILY CONVERTED TO RIGHT OR LEFT HAND OPERATION

APPLICATIONS

- WIRE CAGE
- CAR SEAT
- SPRING MATTRESS
- BAG CLOSURE

SIMILAR TOOLS

- BEA CL24
- BOSTITCH SC7E
- MEIHO MC-6LNA

SC77XE



TOOL SPECIFICATIONS

WEIGHT	1.815KG/4.0LBS
HEIGHT	216MM/8.50"
LENGTH	375MM/14.76"
WIDTH	88MM/3.46"
CAPACITY	100PCS
OPERATING PRESSURE	70-100PSI
AIR INLET	1/4"NPT
TRIGGER	TRIGGER

FASTENER

TYPE	TAPE COLLATED C-RING
LENGTH	15GA
SHANK DIA	1.8MM(.070")
HEAD DIA	19MM(3/4")
NAIL PITCH	8.8MM(.346")
SHANK TYPE	GALVANIZED, ALUMINUM, STAINLESS

FEATURES

- WELL-BALANCED, ERGONOMICALLY DESIGNED
- LARGE CAPACITY LONG MAGAZINE
- RUBBER COMFORT GRIP
- CAN BE EASILY CONVERTED TO RIGHT OR LEFT HAND OPERATION

APPLICATIONS

- WIRE CAGE
- CAR SEAT
- SPRING MATTRESS
- BAG CLOSURE

SIMILAR TOOLS

- BOSTITCH SC77XE

VERTEX CLIPPING TOOL & SPRING STAPLER

เครื่องยิงคลิป

ProClinch™ Clipping Tool



PC4-6080 สำหรับ Clip No.73, 74

PC4-6181 สำหรับ Clip No.3, 4

PC4-6183 สำหรับ Clip No.34

PC4-6189 สำหรับ Clip No.36

Patented polycord collation benefits

- Unlimited shelf life compared to tape-collated clips.
- Ship and handle without breaking.
- Easy to load.
- No residue as with tape-collated clips that can gum up tools, causing increased tool maintenance.
- Welded clips can cause user injuries and can increase tool maintenance.
- Patented "cord lock" collation eliminates jams associated with cords not shearing from clips.

Features

- Lightweight – 35% lighter than competitive models, meaning higher productivity with less operator fatigue.
- 40% fewer components – fewer problems, less maintenance, and increased productivity.
- Easier to handle – the ergonomic design reduces the overall handle-to-trigger dimension by 13%, which makes the tool feel more comfortable to operators with large or small hands.
- Innovative design – includes the use of composite materials and investment castings to ensure light weight, high quality, low maintenance, and increased durability.
- Vertex Fasteners offers many optional accessories for the ProClinch line, including:
 - Blade jam release devices.
 - Pivoting anvils.
 - Fixtured tools.
 - Tool hangers.
 - Counter balancers.
 - Remote activation.
 - Custom features – Vertex engineers will work with you to analyze your application and design a custom solution.

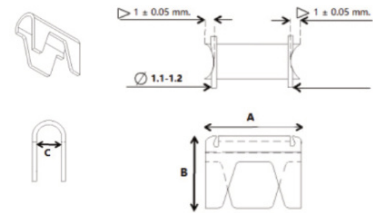

Dimensions				
Product	Vertex NO.	A Width	B Height	C Inside
CL-3	80H235	21.8mm	12.7mm	6.2mm
CL-4	80H235	21.8mm	14mm	6.2mm
CL-34	101H235	21.8mm	17.2mm	6.2mm
CL-71		18.5mm	13.5mm	6.2mm
CL-72	91F23	18.5mm	14.5mm	6.2mm
CLP-312	80F23	18.5mm	12.7mm	5.6mm

ProStick™ Spring Stapler

เครื่องยิงลวดทาส์กิ่ง



VA0317

Single Staple, Standard Weight

WEIGHT	"7.04 IBS. (STANDARD WEIGHT)	
	5.56 IBS. (LIGHTWEIGHT)"	
	HEIGHT	35"
	WIDTH	2.5"
LENGTH	14"	

VA0318

Double Staple, Standard Weight

WEIGHT	"7.04 IBS. (STANDARD WEIGHT)
	5.56 IBS. (LIGHTWEIGHT)"
HEIGHT	35"
WIDTH	2.5"
LENGTH	14"

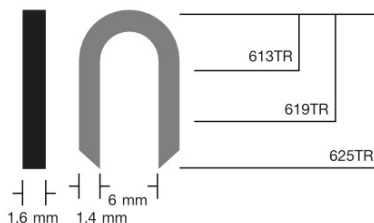

Features

The QuietFire™ valve greatly reduces tool exhaust noise.

All ProStick™ parts are completely interchangeable with competitors' model BCAR tools.

Tools and parts are a fraction of the cost of our competitors'.

Conversion kits are available to convert your current tools to "Lightweight" or "QuietFire™" tools.

Rounded lower handgrip, with no-slip lip, gives better control and increased operator comfort.

Built-in flats on the handle make tool disassembly a breeze.

Vertex WireLok™ spring staples incorporate 2 separate adhesives, resulting in superior holding power.

LOCK CARTON STAPLER

เครื่องเย็บฟากกล่อง

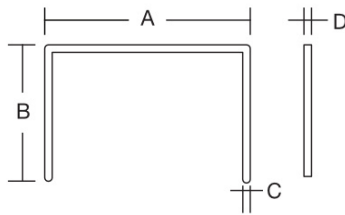

888-BIII เครื่องเย็บฟากกล่องใช้มือกด

LOCK standard stapler.

Handy & easy

Air / Electric power-free

SPECIFICATIONS

น้ำหนัก	2.1 กก.
ขนาด (กxยxส)	110x430x280
ความดันลม	-
ปริมาณลม	-

	3416	3419
A	34 mm	34 mm
B	16 mm	19 mm
C	0.78 mm	0.78 mm
D	2.27 mm	2.27 mm

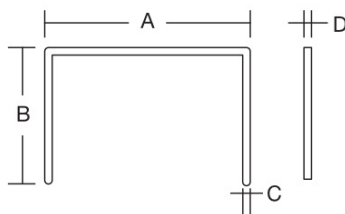
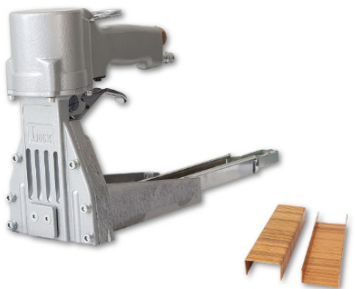

888-CNT เครื่องเย็บฟากกล่องใช้ลม

Compact model of 888-CN

Lightweight, work easily

Silencer installed.

Also suitable for indoors work, of course.

SPECIFICATIONS

น้ำหนัก	2.4 กก.
ขนาด (กxยxส)	110X410X210
ความดันลม	6-7 กก. / ตร.ซม
ปริมาณลม	2.0 ลิตร / 1 ชิ้น

	3416	3419
A	34 mm	34 mm
B	16 mm	19 mm
C	0.78 mm	0.78 mm
D	2.27 mm	2.27 mm

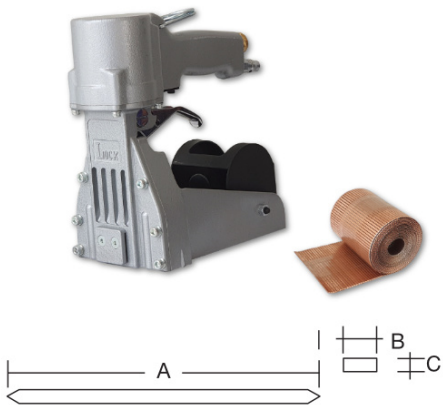

888-CRN เครื่องเย็บฟากกล่องลวดม้วนใช้ลม

Compact model of 888-CR

Light weight, work easily

An astonishing rapid performance

Silencer installed

SPECIFICATIONS

น้ำหนัก	2.8 กก.
ขนาด (กxยxส)	110X215X210
ความดันลม	6-7 กก./ตร.ซม.
ปริมาณลม	2.0 ลิตร / 1ชิ้น

1M = 1,000 pcs / Roll

5M = 5,000 pcs / Roll

	CCS18C-1M,5M	CCS18G-1M,5M
A	64 mm	65 mm
B	1.9 mm	1.9 mm
C	0.85 mm	0.85 mm

TSN CARTON STAPLER

เครื่องเย็บฟากกล่อง

CARTON STAPLER

เครื่องเย็บฟากกล่อง



TSN-HA-19-35



TSN-AA-19-35



TSN-AA-22-35

CARTON BOTTOMER

เครื่องเย็บก้นกล่อง



TSN-CMB-S-35



TSN-CAB-S-35

SPECIFICATIONS

MODEL	W X L X H (CM.)	WEIGHT (CM.)	STAPLE LENGTH (CM.)	STAPLE CAPACITY (PCS.)	OPERATION TYPE
TSN-HA-19-35	11.5 X 43.3 X 22	2.2	15,16,18,19	100	MANUAL
TSN-AA-19-35	11.5 X 41.5 X 22	2.65	15,16,18,19	100	AIR (5-7 KG. / CM ²)
TSN-AA-22-35	11.5 X 41.5 X 22	2.65	22	100	AIR (5-7 KG. / CM ²)
TSN-CMB-S-35	60 X 91 X 124.5	26.8	15,16,18,19,22	200	MANUAL
TSN-CAB-S-35	60 X 83 X 124.5	22.7	15,16,18,19,22	200	AIR (5.5-6 KG. / CM ²)



SPECIFICATIONS OF STEEL STAPLE

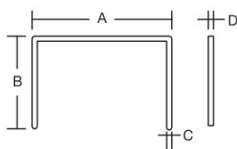

	3415	3416	3419	3422
A	34 mm	34 mm	34 mm	34 mm
B	15 mm	16 mm	19 mm	22 mm
C	0.78 mm	0.78 mm	0.78 mm	0.78 mm
D	2.27 mm	2.27 mm	2.27 mm	2.27 mm

SPECIFICATIONS OF ROLL STAPLE



	CCS18C-1M,5M 1M = 1,000 pcs / Roll	CCS18G-1M,5M 5M = 5,000 pcs / Roll
A	64 mm	64 mm
B	1.9 mm	1.9 mm
C	0.85 mm	0.85 mm